

DS-2CD2432F-I (W) 3MP IR Cube Network Camera



Key features

- Up to 3.0 megapixel (2048 x 1536) resolution
- Full HD1080p real-time video
- PIR detection
- IR LEDs (up to 10m)
- DWDR & 3D DNR & BLC
- Built-in microphone & speaker
- SD/SDHC/SDXC card slot (up to 64Gb)
- Wi-Fi optional (WPS connection)

Dimensions

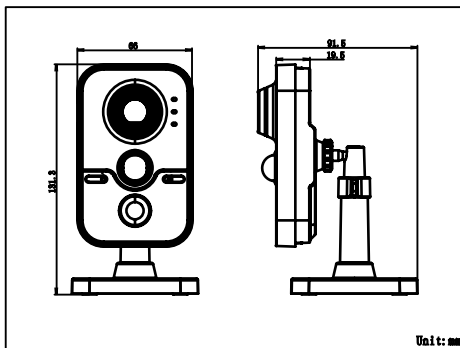

DS-2CD2432F-I (W)	
Camera	
Image sensor	1/3" progressive scan CMOS
Min. illumination	0.07 lux@F1.2, AGC on 0 lux with IR
Shutter time	1/25s (1/30s) ~ 1/100,000s
Lens	4mm@F2.0, angle of view: 79° (2.8mm, 6mm, 12mm optional)
Lens mount	M12
Day & night	ICR
Digital noise reduction	3D DNR
Wide dynamic range	Digital WDR
Backlight compensation	Yes, zone configurable
Compression standard	
Video compression	H.264 / MJPEG
H.264 compression profile	Main profile
Bit rate	32 Kbps ~ 16 Mbps
Audio compression	G.711 / G.726
Audio bit rate	64 Kbps (G.711) / 16 Kbps (G.726)
Image	
Max. image resolution	2048 x 1536
Frame rate	50Hz: 20fps (2048 x 1536), 25fps (1920 x 1080), 25fps (1280 x 720) 60Hz: 20fps (2048 x 1536), 30fps (1920 x 1080), 30fps (1280 x 720)
Image settings	Saturation, brightness, contrast adjustable through client software or web browser
Network	
Network storage	NAS (iSCSI optional)
Alarm trigger	PIR detection, motion detection, tampering alarm, network disconnect, IP address conflict, storage exception, storage error
Protocols	TCP/IP, ICMP, HTTP, HTTPS, FTP, DHCP, DNS, DDNS, RTP, RTSP, RTCP, PPPoE, NTP, UPnP, SMTP, SNMP, IGMP, 802.1X, QoS, IPv6, Bonjour (SIP optional)
System compatibility	ONVIF, PSIA, CGI
General functionalities	Flickerless, dual stream, heartbeat, mirror, user authentication, video mask, watermark
Interface	
Communication interface	1 RJ45 10M / 100M ethernet port
Onboard storage	Built-in Micro SD/SDHC/SDXC card slot, up to 64 GB
Alarm I/O	1/1
Wi-Fi parameters (only for -W model)	
Wi-Fi standard	IEEE802.11b/g/n
Frequency range	2.4 GHz ~ 2.4835 GHz
Communication bandwidth	Support 20/40 MHz
Security	64/128-bit WEP, WPA/WPA2, WPA-PSK/WPA2-PSK, WPS
Transmission rate	11b: 11Mbps, 11g: 54Mbps, 11n: 150Mbps
Transmission range	Outdoor: up to 200 meters; Indoor: up to 50 meters. * It varies depending on actual environment.
General	
Operating conditions	-30°C ~ 60°C (-22°F ~ 140°F) humidity 95% or less (non-condensing)
Power supply	12 VDC ± 10%, PoE (802.3af)
Power consumption	Max. 5W
PIR detection range	Max. 10m
PIR detection angle	80°
IR range	Max. 10m
Dimensions (mm)	66 x 91.5 x 131.3 (2.60" x 3.60" x 5.17")
Weight	400g (0.88lbs)

Available models

DS-2CD2432F-I, DS-2CD2432F-IW

* -W: Wi-Fi

* Product picture and technical specs subject to change without previous notice.

For further information, please contact our local sales representatives.